

OPERATING INSTRUCTIONS AND PARTS MANUAL

MODEL ZN-12M12

Decorative Nailer

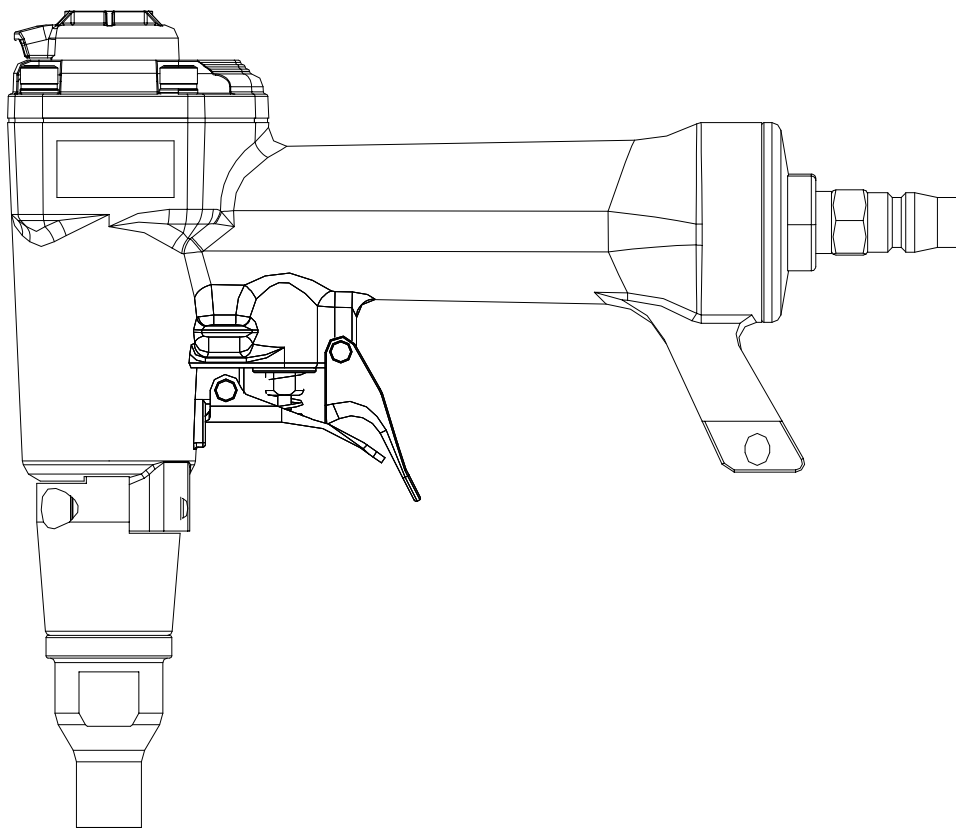

CAREFULLY READ THIS MANUAL BEFORE OPERATING TOOL

TOOL SPECIFICATIONS

MODEL OF TOOL	ZN-12M12
TOOL LENGTH	9.06" (230 mm)
TOOL HEIGHT	7.09" (180 mm)
TOOL WIDTH	2.76" (70 mm)
WEIGHT (WITHOUT FASTENERS)	1.65 lbs (0.75 kg)
AIR INLET	1/4" NPT
COMPRESSED AIR :	
Maximum permissible operating pressure	110 PSIG (7.5 bar)
Recommended operating pressure range	65 - 90 PSIG (4.5 - 6 bar)
AIR CONSUMPTION.....	0.0043 scfm with 25 nails per minute @ 90 psi (6.2 bar)

Noise dB(A) :	
A-weighted sound pressure level LpA.....	80.52 dB(A)
A-weighted sound power level LwA.....	93.52 dB(A)
Measurement uncertainty: 3dB	
Vibration (m/s²) :	
Hand-arm vibration value.....	1.9 m/s ²
Measurement uncertainty: 1.5 m/s ²	

Warning:

The vibration emission during actual use of the power tool can differ from the declared total value depending on the ways in which the tool is used; and of the need to identify safety measures to protect the operator that are based on an estimation of exposure in the actual conditions of use (taking account of all parts of the operation cycle such as the times when the tool is switched off and when it is running idle in addition to the trigger time).

List of fasteners for ZN12M12 :

Crown	Length	MAGAZINE
11.8 mm , 0.46 "	9.0 mm ~ 19 mm , 0.35 " - 0.74 "	1 pcs

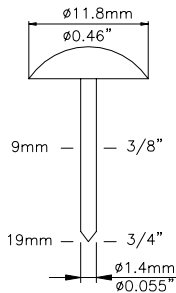

Foreword:

This pneumatic nailer is designed for using on soft material or driving tacks/decorative nails into wood. Its well balanced, ergonomic and comfort non-slip cushioned grip ensure you a satisfactory tackle and improve work efficiency. One of features is to drive different sizes of loose nails. No more painful hammering.

Suitable applications:

Leather upholstery, shoes, antique, trimming mattresses

Caution:

Staplers are only applying on wood. Not suitable for stapling or nailing into concrete, masonry bricks or steel. Do not fire if staples are jammed, as this will cause damage to the relevant parts.



Indicates an imminently hazardous situation which, if not avoided, will result in death or serious injury.

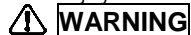

Indicates a potentially hazardous situation which, if not avoided, will result in death or serious injury.

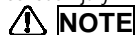

Alerts the operator to useful information.

SAFETY INSTRUCTIONS



1. Read this manual and understand all safety instructions before operation the tool. If you have any questions, please contact our authorized representatives.
2. Only those fasteners listed in the operating instructions may be used in the fastener driving tools.
3. Only the main energy and the lubricants listed in the operating instructions may be used.
4. Fastener driving tools marked with an inverted equilateral triangle standing on one point may only be used with an effective safety yoke.
5. Fastener driving tools equipped with contact actuation or continuous contact actuation, marked with the symbol " Do not use on scaffoldings, ladders", shall not be used for specific application for example: when changing one driving location to another involves the use of scaffoldings, stairs,

ladders, or ladder alike constructions, e.g. roof laths, closing boxes or crates, fitting transportation safety systems e.g. on vehicles and wagons.

6. For the maintenance of fastener driving tools, only spare parts specified by the manufacturer or his authorized representative shall be used.
7. Repairs shall carried out by agents authorized by the manufacturer or by other specialists, having due regard to the information given in the operating instruction.
8. Stands for mounting the fastener driving tools to a support for example a work table shall be designed and constructed by the stand manufacturer in such a way that the fastener driving tool can be safely fixed for the intended use, thus for example avoiding damage, distortion or displacement.
9. Fastener driving tools operated by compressed air shall only be connected to compressed air lines where the maximum allowable pressure cannot be exceeded by a factor of more than 10%, which can for example be achieved by a pressure reduction valve which includes a downstream safety valve.
10. When using fastener driving tools operated by compressed air, particular attention must be paid to avoid exceeding the maximum allowable pressure.
11. When using fastener driving tools operated by compressed air should only be operated at the lowest pressure required for the work process at hand, in order to prevent unnecessarily high noise levels, increased wear and resulting failures.
12. Hazards caused by fire and explosion when using oxygen or combustible gases for operating compressed air operated fastener driving tools.
13. Carry the fastener driving tool at workpiece using only the handgrip, and never with the trigger actuated. Never carry the tool by the hose or pull the hose to move the tool.

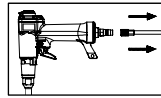

14. Disconnect the tool from air supply before cleaning jams, servicing, adjusting, and during non-operation.



15. Wear eye protection.

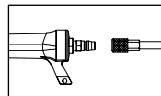

16. Do not use a check valve or any other fitting which allows air to remain in the tool.



17. Do not place your hand or any part of your body in the fastener discharge area of the tool when connecting or disconnecting air supply.



18. Never point tool at yourself or at any other person.

AIR SUPPLY AND CONNECTION



Many air tool users find it convenient to use oiler to help provide oil circulation through tool and increase the efficiency and useful life of the tool. Check oil level in the oiler daily.

Many air tool user find it convenient to use a filter to remove liquid and impurities which can rust or wear internal parts of the tool. A filter also increase the efficiency and useful of the tool. The filter must be checked on a daily basis and if necessary drained.

For better performance, install a 3/8" quick connector (1/4" NPT threads) with an inside diameter of .315" on your tool and a 3/8" quick coupler on the air hose.

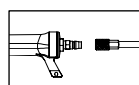
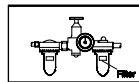
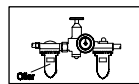

The following illustration shows the correct mode of connection to the air supply system which will increase the efficiency and useful life of the tool.

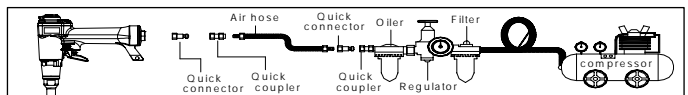

LUBRICATION AND MAINTENANCE



Disconnect the air supply from the tool before lubricating.

Your tool requires lubrication before you use it for the first time.

Wipe off excessive oil at the exhaust. Excessive oil will damage O-rings of tool. If in-line oiler is used, manual lubrication through the air inlet is not required on a daily basis.

Turn the tool so the inlet is facing up and put one drop of high speed spindle oil, UNOCAL RX22, or 3-IN-1 oil into air inlet. Never use detergent oil or additives. Operate the tool briefly after adding oil.

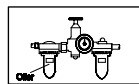
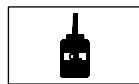
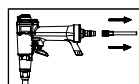

LOADING THE TOOL

WARNING



Do not place your hand or any part of your body in the fastener discharge area of the tool when connecting or disconnecting air supply.

WARNING



Never point any operational fastener driving tool at yourself or at any other person.

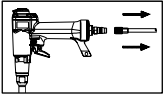

1. Disconnect air hose.

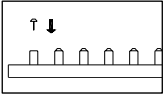

2. Place decorative upholstery nails into the template for perfect alignment of the nail into the ZN-12M.

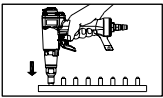

3. When you press the tool over the template the magnet inside the nose will pick the nail and seat it properly for straight and effortless driving of nails.

OPERATING THE TOOL

WARNING



Protect your eyes and ears. Wear z87.1 safety glasses with side shields. Wear hearing protection. Employers and users are responsible for ensuring the user or anyone near the tool wear this safety protection.

NOTE

Check and replace any damaged or worn components on the tool. The safety warning labels on the tool must also be replaced if they are not legible.



Fig.1

1. Add a few drops of UNOCAL RX22 or 3-in-1 oil into the air inlet. (See Fig. 1)

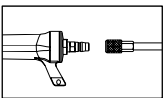

Fig.2

2. Attach a high flow quick connect fitting to the tool. (See Fig. 2)

3. Empty the magazine.

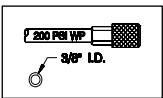

Fig.3

4. Connect the tool to an air compressor using a 3/8" I.D hose. Make sure the hose has a rated working pressure exceeding 200 PSI (13.8bar) and a female quick coupler. (See Fig. 3)



Fig.4

5. Regulate the air pressure to obtain 70 PSI (4.8 bar) at the tool. (See Fig. 4)

6. Disconnect the air supply from the tool.

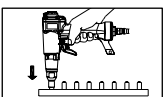

Fig.5

7. Load fasteners into your tool following the instructions in this manual. (See Fig. 5)

8. Reconnect the air supply to the tool.

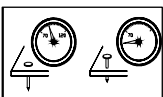

Fig.6

9. Test for proper fastener penetration by driving nails into a sample piece of wood. If the fasteners do not achieve the desired penetration, adjust the air pressure to a higher setting until the desired penetration is achieved. Do not exceed 110 PSI (7.6 bar) at the tool. (See Fig. 6)

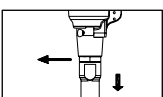
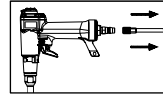

Fig.7

10. Measure nail head height first. Loosen the screw and adjust the mouthpiece to the proper position that doesn't hurt nail head surface, screw tight the screw. (See Fig. 7)

CLEARING A JAM FROM THE TOOL

WARNING



Disconnect the tool from air compressor before adjusting, clearing jams, servicing, relocating and during non-operation.

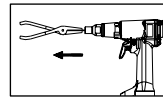

Fastener jammed in fastener discharge area:
Disconnect tool from air hose.
Grab jammed fastener with pliers and remove.

CLEANING THE TOOL

DANGER



Never use gasoline or other flammable liquids to clean the tool. Vapors in the tool will ignite by a spark and cause the tool to explode and result in death or serious personal injury.

NOTE

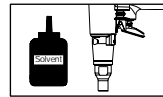

Solvents used to clean the nose of the tool and contact safety trip mechanism may soften the tar on the shingles and cause the buildup to be accelerated. Make sure to dry the tool thoroughly after cleaning and before operating the tool again.

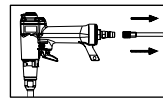

1. Disconnect the air supply from the tool.

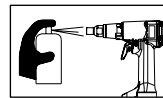

2. Remove tar buildup with kerosene #2 fuel oil or diesel fuel. Do not allow solvent to get into the cylinder or damage may occur. Dry off the tool completely before use.

TROUBLESHOOTING

Stop using the tool immediately if any of the following problems occur. Serious personal injury could. Any repairs or replacements must be done by a qualified person or an authorized service center only.

PROBLEM	PROBABLE CAUSE	REMEDY
Air leaking at trigger valve area.	O-rings in trigger valve housing are damaged.	O-rings must be replaced.
Air leaking between housing and nose.	Loose screws in housing. Damaged to bumper.	Screws need to be tightened. O-rings must be replaced.
Air leaking between housing and cap Assy.	Damage to bumper. Loose screws. Damaged seal.	Bumper needs to be tightened. Screws need to be tightened. Seal needs to be replaced.
Tool skips driving fastener.	Worn bumper. Dirt in nose. Dirt or damage prevents fasteners from moving freely in magazine. Inadequate air flow to tool. Worn O-ring on piston or lack of lubrication.	Bumper needs to be replaced. Clean. Magazine needs to be cleaned. Fitting hose or air compressor needs to be checked. O-ring needs to be replaced. Lubricate.
Tool runs slow or has loss of power.	Damaged O-rings on trigger valve. Air leaks. Cap seal leaking.	O-rings need to be replaced. Screws and fittings need to be tightened. Seal needs to be replaced.
Fasteners are jammed in tool.	Tool not lubricated sufficiently. Broken spring in cap Assy. Exhaust port in cap is blocked.	Tools needs to be lubricated. Spring needs to be replaced. Damaged internal parts need to be replaced.
	Driver nozzle worn or damaged. Driver is damaged. Fasteners are not correct size. Fasteners are bent. Magazine or nose screws are loose.	Replace driver nozzle. Replace driver. Fasteners recommended for tool must be used. Replace with undamaged fastener. Screws need to be tightened.

ZN-12M12A01 (WO/M12A-01)

C

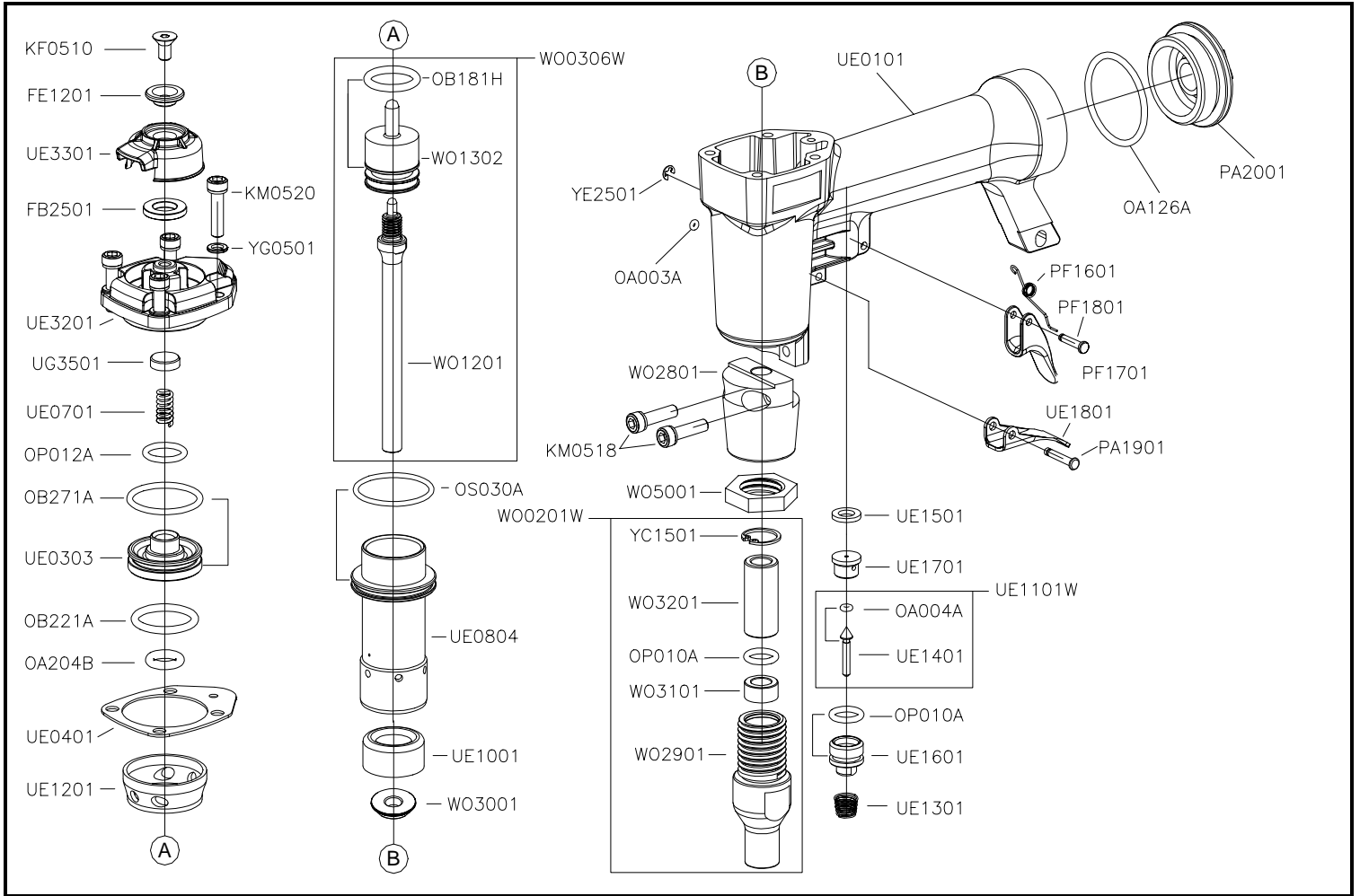

Part_No	Description	Spec	Q'ty	Part_No	Description	Spec	Q'ty	Part_No	Description	Spec	Q'ty
FB2501	PISTON STOP		1	UE0401	CAP SEAL		1	WO3101	PERMANENT MAGNET		1
FE1201	EXHAUST CAP RING		1	UE0701	COMPRESSION SPRING		1	WO3201	SHAFT		1
KF0510	FLAT HD.BOLT	M5×0.8 - 10L	1	UE0804	CYLINDER		1	WO5001	SCREW		1
KM0518	HEX.SOC.HD.BOLT	M5×0.8 - 18L	2	UE1001	BUMPER		1	YC1501	C-RING	15	1
KM0520	HEX.SOC.HD.BOLT	M5×0.8 - 20L	4	UE1101W	TRIGGER VALVE ASSY.		1	YE2501	E-RING	2.5	1
OA003A	O-RING	ARP568-003	1	UE1201	COLLAR		1	YG0501	SPRING WASHER	5	4
OA004A	O-RING	ARP568-004	1	UE1301	COMPRESSION SPRING		1				
OA126A	O-RING	ARP568-126	1	UE1401	TRIGGER VALVE STEM		1				
OA204B	O-RING	ARP568-204	1	UE1501	SEAL		1				
OB181H	O-RING	17.7×3.0	1	UE1601	TRIGGER VALVE GUIDE		1				
OB221A	O-RING	22×3	1	UE1701	TRIGGER VALVE SEAT		1				
OB271A	O-RING	26.8×2.4	1	UE1801	TRIGGER		1				
OP010A	O-RING	P10	2	UE3201	CYLINDER CAP		1				
OP012A	O-RING	P12	1	UE3301	EXHAUST CAP		1				
OS030A	O-RING	S-30	1	UG3501	PISTON STOP		1				
PA1901	PIN		1	WO0201W	MOUTHPIECE ASSY.		1				
PA2001	END CAP		1	WO0306W	DRIVER ASSY.		1				
PF1601	SPRING		1	WO1201	DRIVER		1				
PF1701	SAFETY LEVER		1	WO1302	MAIN PISTON		1				
PF1801	PIN		1	WO2801	NOSE		1				
UE0101	BODY		1	WO2901	MOUTHPIECE		1				
UE0303	HEAD VALVE PISTON		1	WO3001	NOZZLE		1				

If you need to order parts, please mark both Parts No. and Description.